

MODEL 630

HINGED STEEL BELT CONVEYOR



The **Model 630 Titan Hinged Steel Belt Conveyor** is the full profile unit in our complete line of hinged steel belt conveyors. The Model 630 is constructed of 10 gauge frame and 3/16" thick track. Four different configurations are available to provide complete flexibility to fit your requirements. A 2-1/2" pitch belt with 1-1/2" high stamped sidewings and 12 gauge apron is furnished as standard. The top mounted drive with 8-1/2" clearance is standard with optional side mounted drive available. Three curve angles (30°, 45°, 60°) are offered as standard. (other degree curves optional). Marine bearings or outboard bearings can be supplied depending on the application. Consult the factory for further details.



MODEL 630 - 2-1/2" PITCH HINGED STEEL BELT MODELS

	Standard	Options
Belt Width	6", 8", 12", 18", 24", 30", 36"	Others Available
Belt Type	2 1/2" pitch 1-1/2" standard stamped sidewing	Perforated, pimpled, pimpled & perforated, welded barrels, impact plates
Curves	30°, 45°, 60°	
Frame	8-5/8" deep formed 10 ga.	
Drive	1/2 H.P. 230/460/3/60	3/4, 1, 1-1/2, 2 H.; 115/230/1/60, 575/3/60 severed duty, inverter duty, brake motor
Drive Sprocket	6 Tooth, 5" P.D.	
Chain Pull	1500# without sidebars	3000# with sidebars

OPTIONS

Drive location, H.P., fixed and variable speed, controls, coolant tanks, chutes, plumbing, top covers, chip suppressors, casters, liquid tight bottom pans, 3 bolt flange bearings or T-slot bearings at infeed, paint, supports, Belt: pimpled, perforated, welded barrels, impact plates, wiper cleats, cleat heights, sidebars on narrower belts, side rail heights, rotary belt brush

Many other options available, consult factory representative

NOTE: Specifications subject to change without notice

MODEL 630

HINGED STEEL BELT CONVEYOR

Conveyor Profiles available:

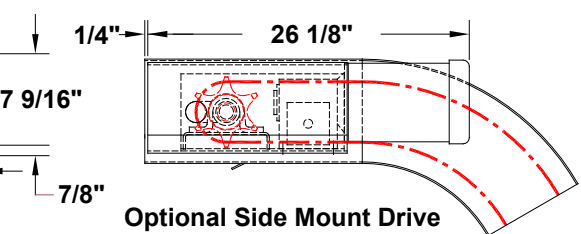
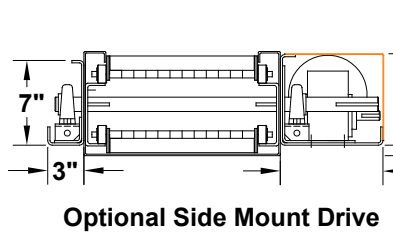
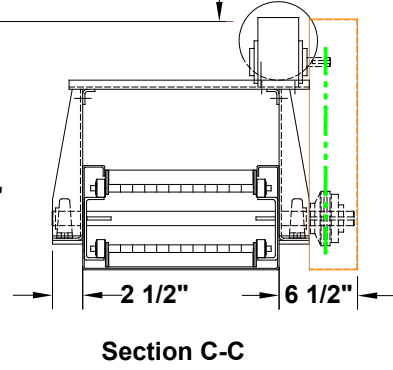
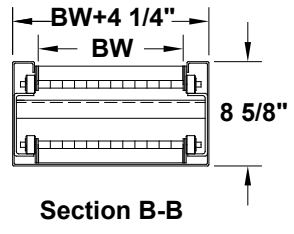
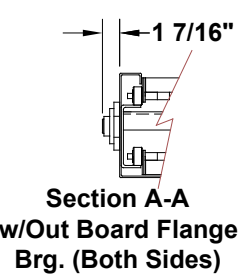
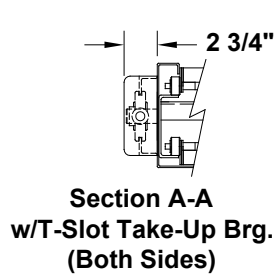
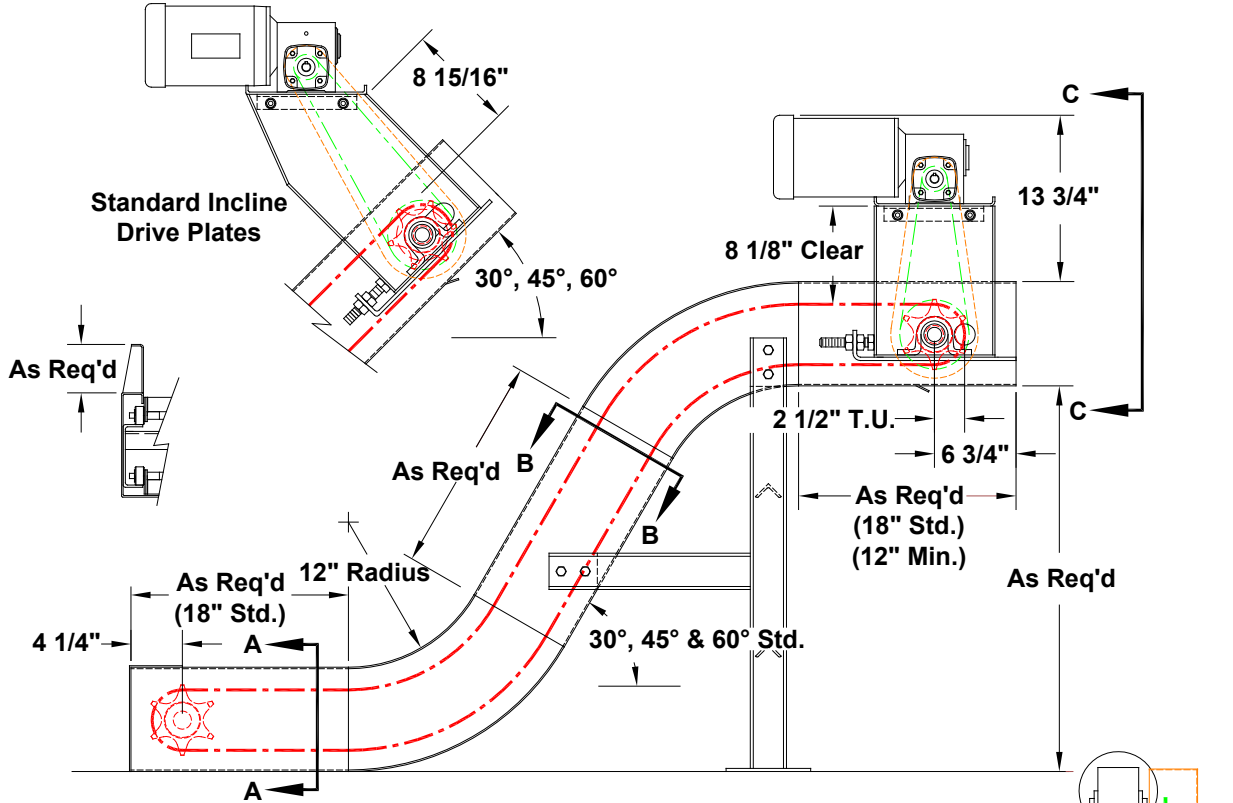
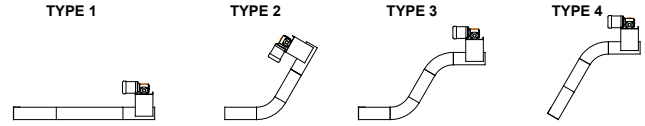

735 Industrial Loop Road • New London, WI 54961-9612
 920-982-6600 • Fax 920-982-7750 • Toll Free 800-558-3616
 Website: www.titanconveyors.com • Email: sales@titanconveyors.com

